

# Blade Baffle: Luray

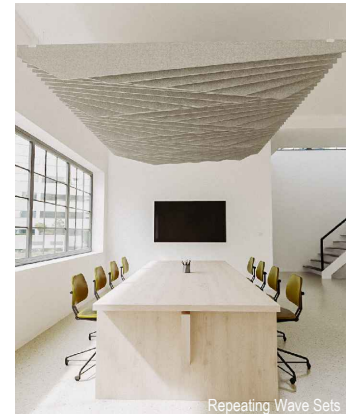

## Height Options

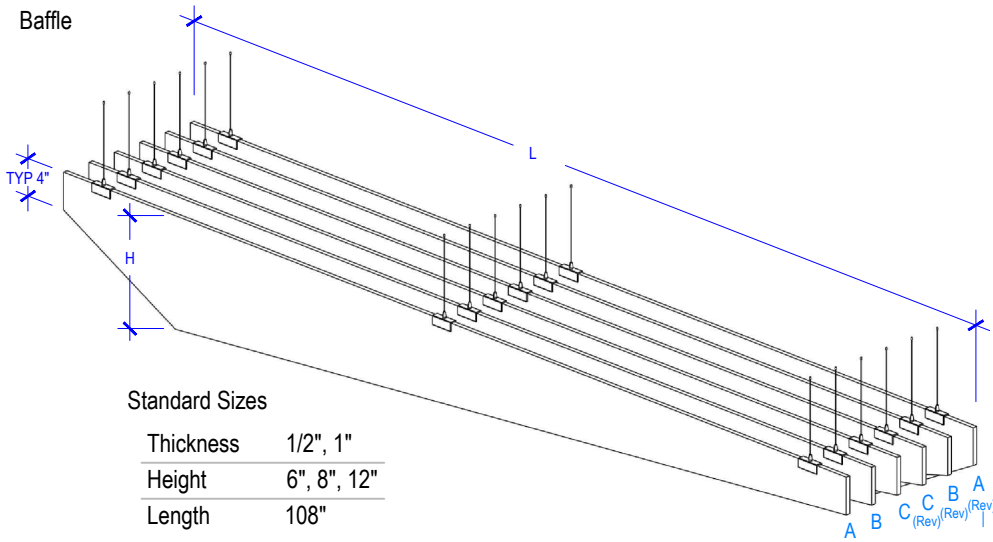
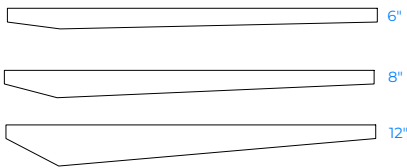

## Profiles

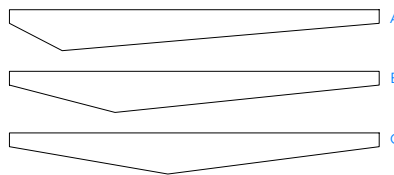

## Hardware

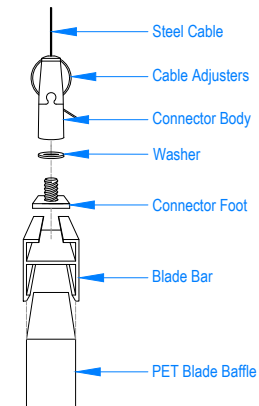

## Pattern Sets

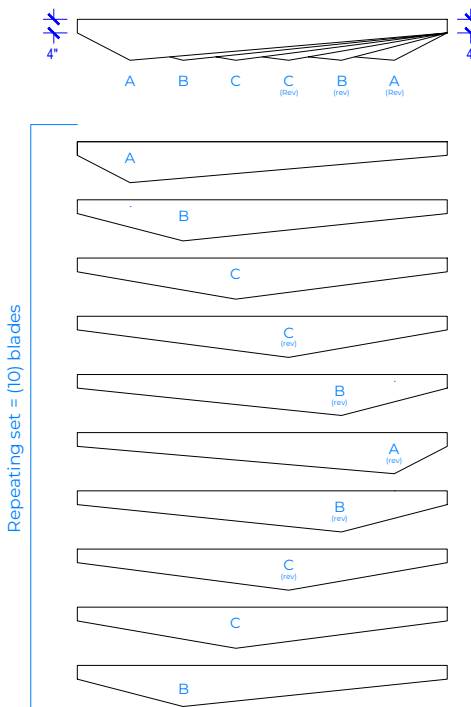

## Installation

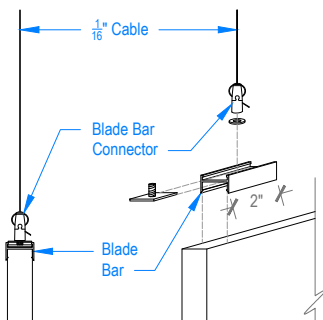

## Baffle & Cloud Specifications

Panel Thickness	1/2" or 1"
Colors - PET	28
TYP Panel Size	TYP 48" x 108"
Material	100% Polyester
Recycled Content	60%
NRC	0.45 - 0.75
Fire Rating	Class A
Mounting	Cable & hanging hardware, or magnets

## Notes:

24 colors + 4 woodgrain prints

Blade Bar available in either 2-inch sections or in full lengths up to 9 feet

Connectors, per 9-foot baffle:

Full Blade Bar: 2 recommended

Partial or no Blade Bar: 3 recommended to maintain alignment

Baffles over 9 feet in length will be butt-joined

Blade Bar standard finish is aluminum, powder coating available

Custom sizes available upon request